

Junction Box templates: 4x4 "OCTAGON" J-box  
Please print as 1:1 Scale on 8x11 Letter for best results

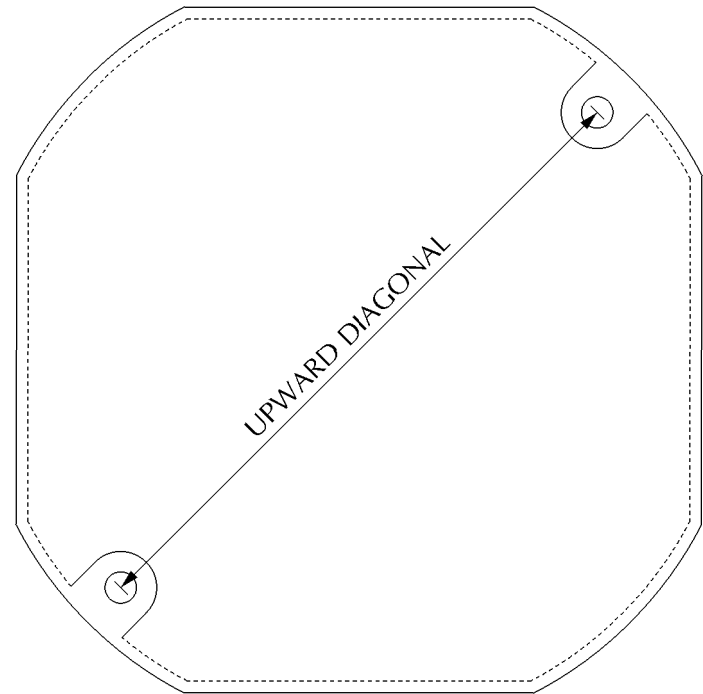

Junction Box templates: 4x4 "OCTAGON" J-box  
Please print as 1:1 Scale on 8x11 Letter for best results

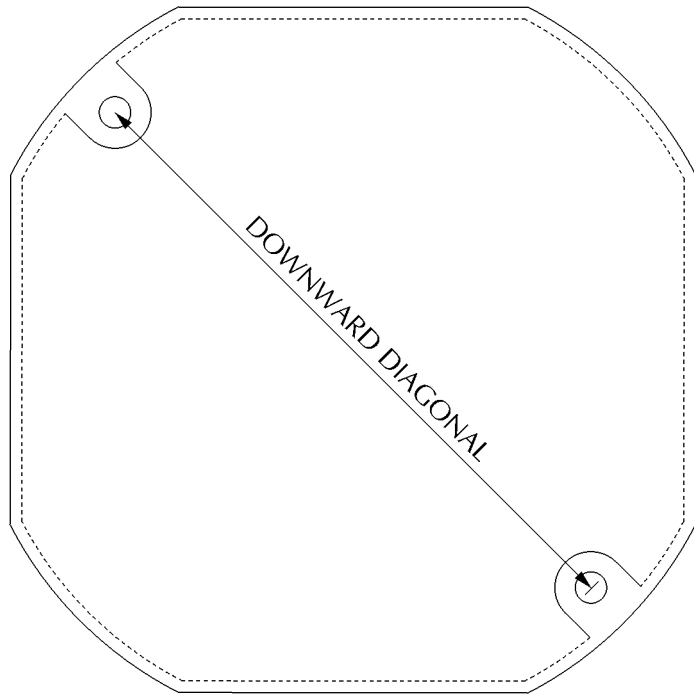
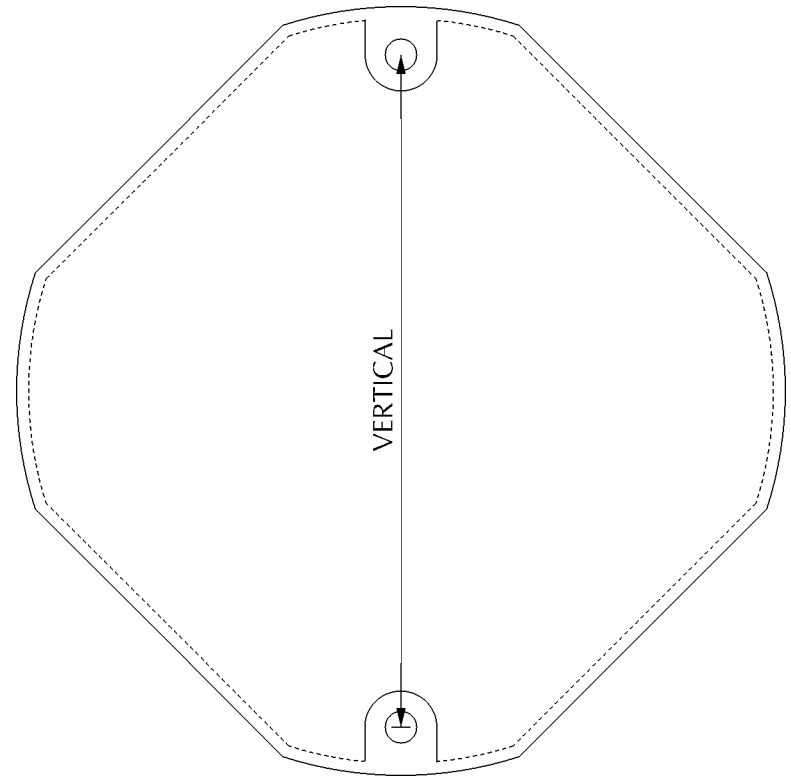
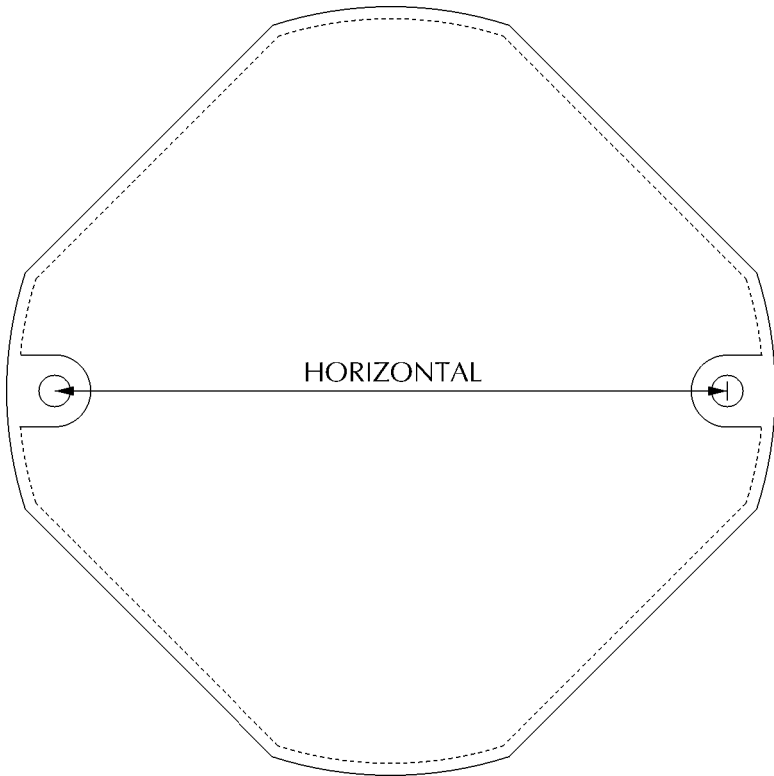

Junction Box templates: 4x4 "OCTAGON" J-box  
Please print as 1:1 Scale on 8x11 Letter for best results

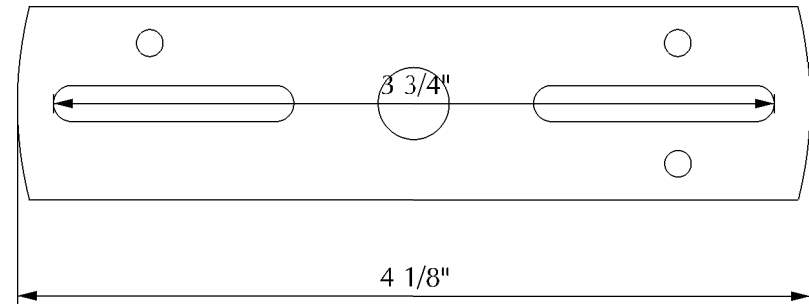
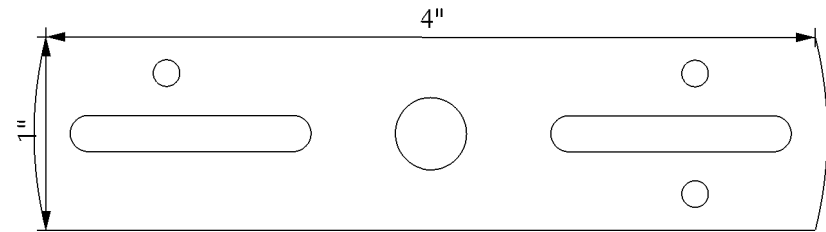
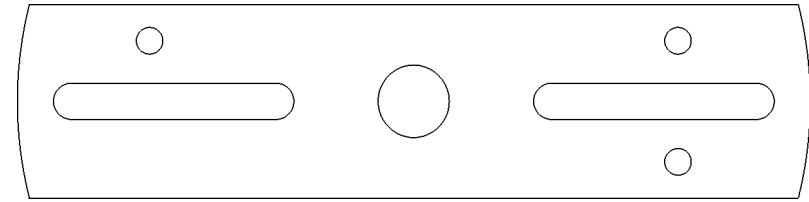
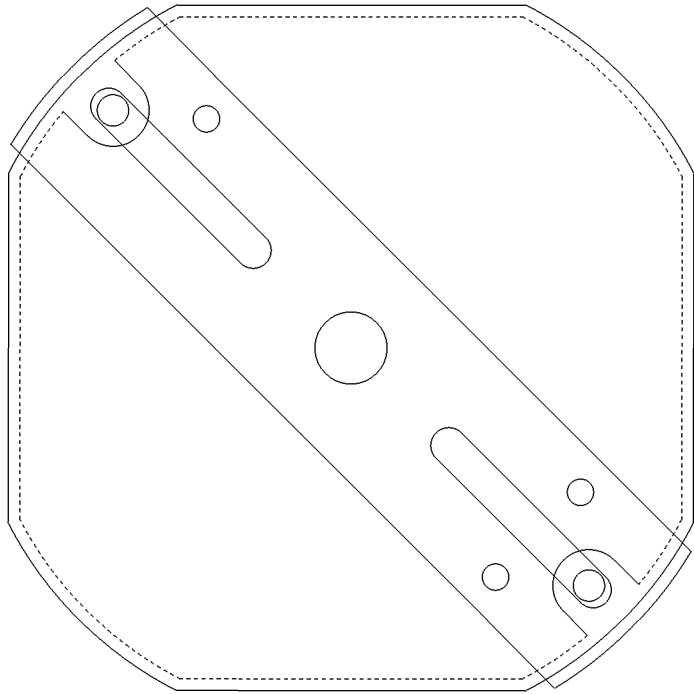

Junction Box templates: 4x4 "OCTAGON" J-box  
Please print as 1:1 Scale on 8x11 Letter for best results

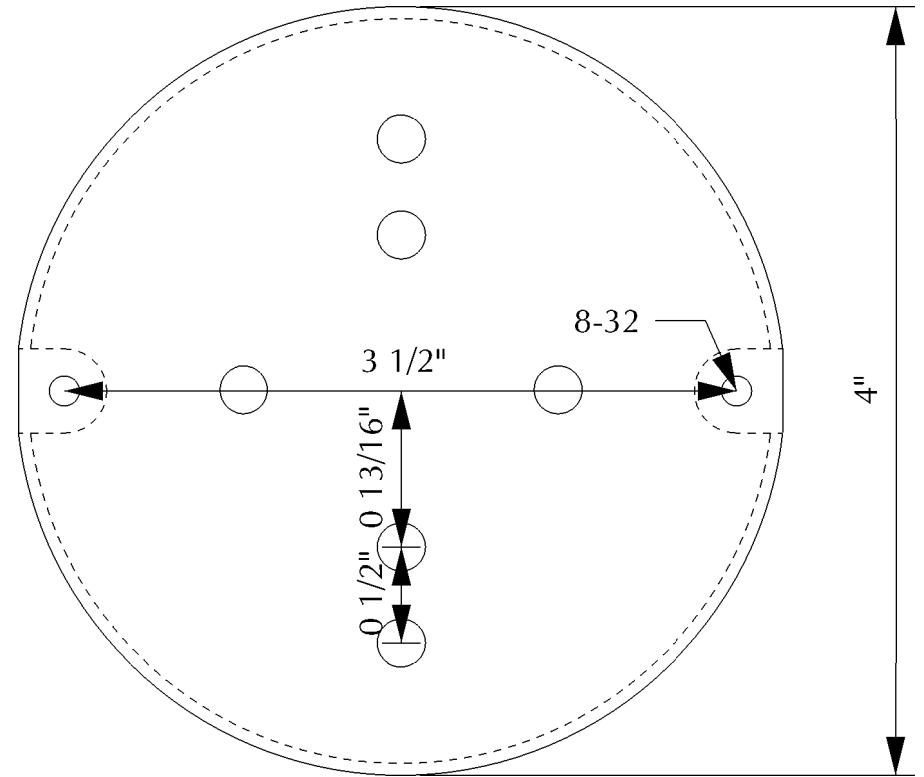
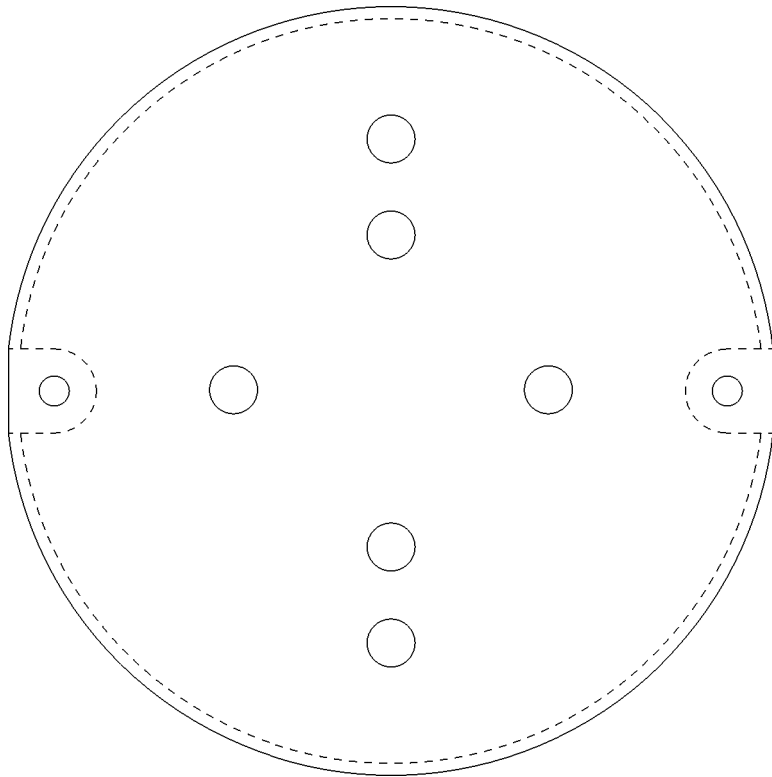

Junction Box templates: Roundpan  
Please print as 1:1 Scale on 8x11 Letter for best results

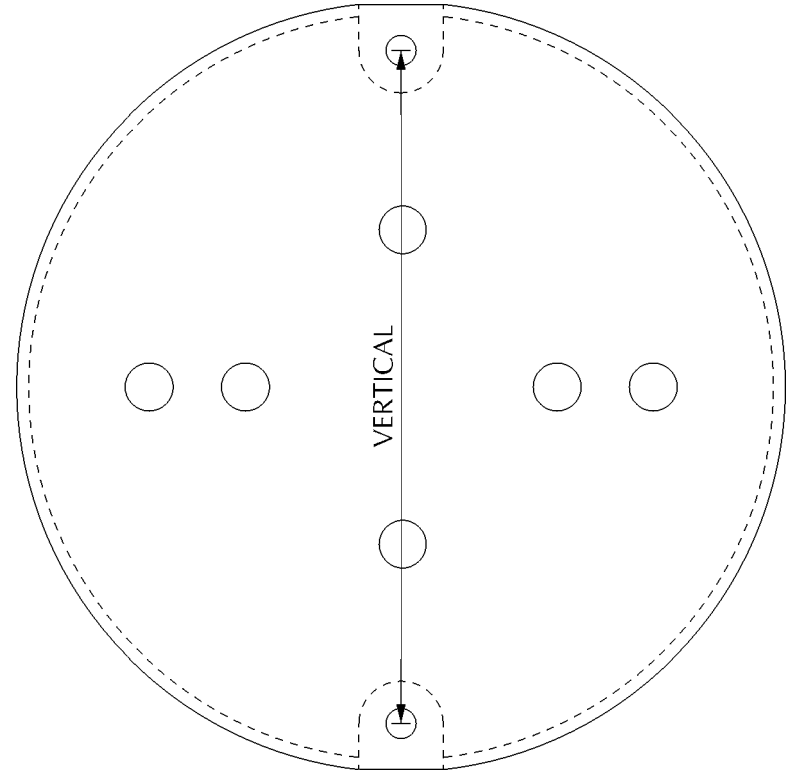
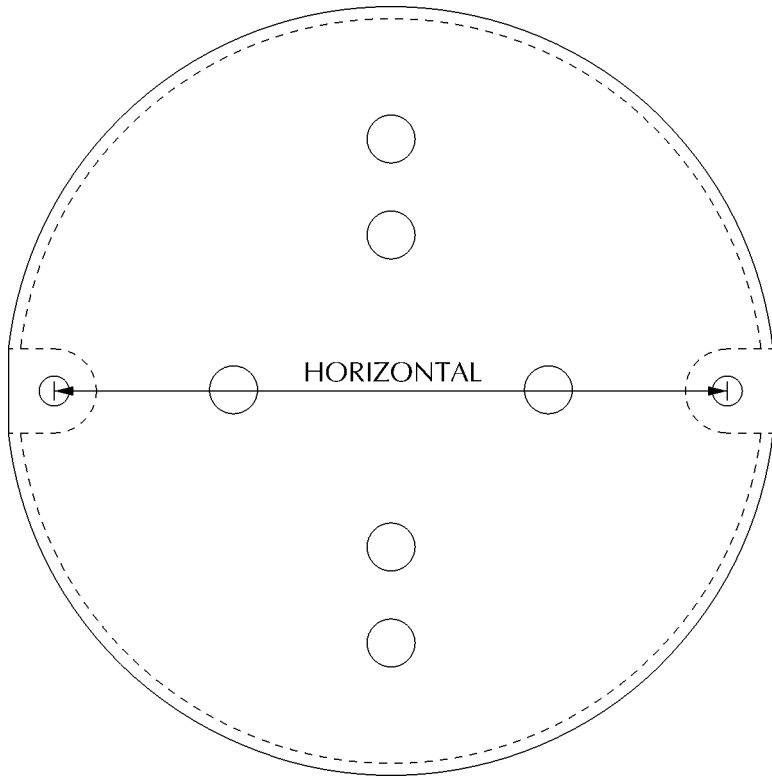

Junction Box templates: Pan J-box Orientation  
Please print as 1:1 Scale on 8x11 Letter for best results



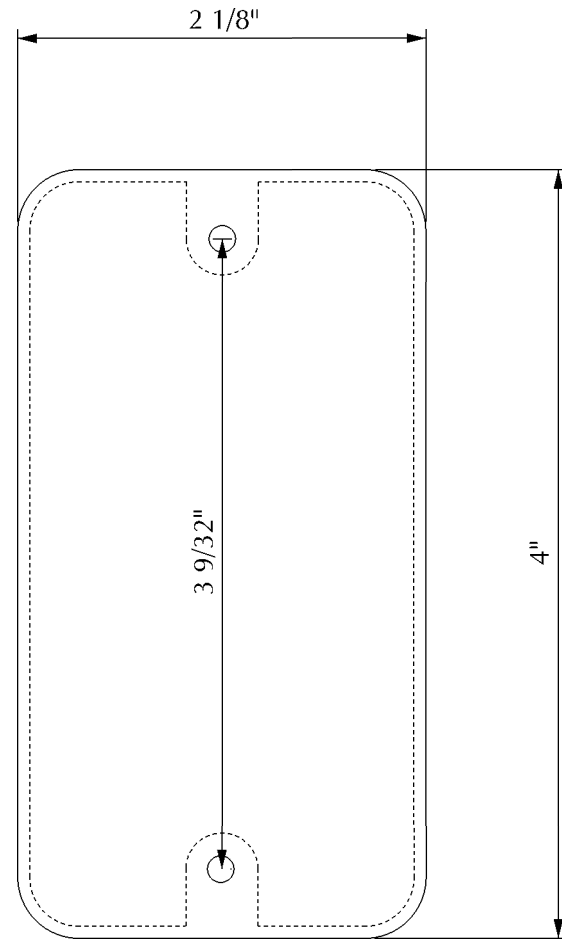
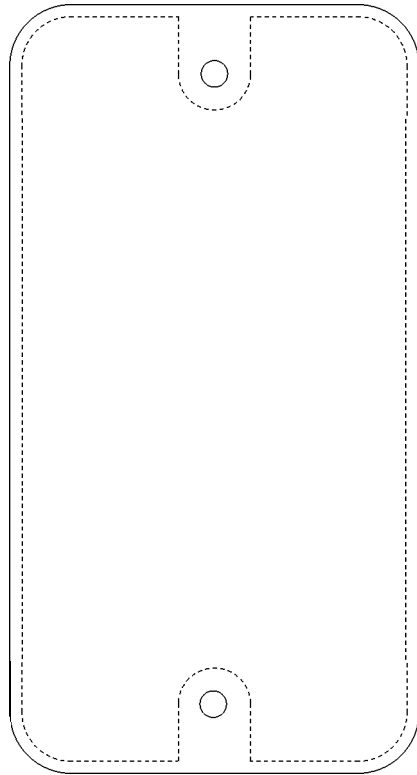

Junction Box templates: 2x4 "Handybox" Wall J-box  
Please print as 1:1 Scale on 8x11 Letter for best results

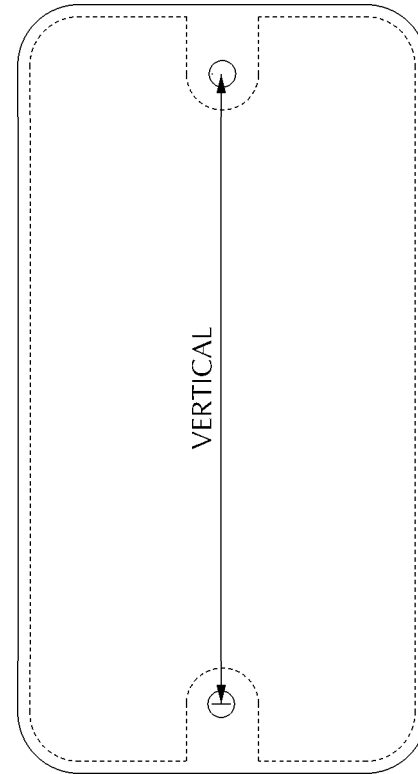
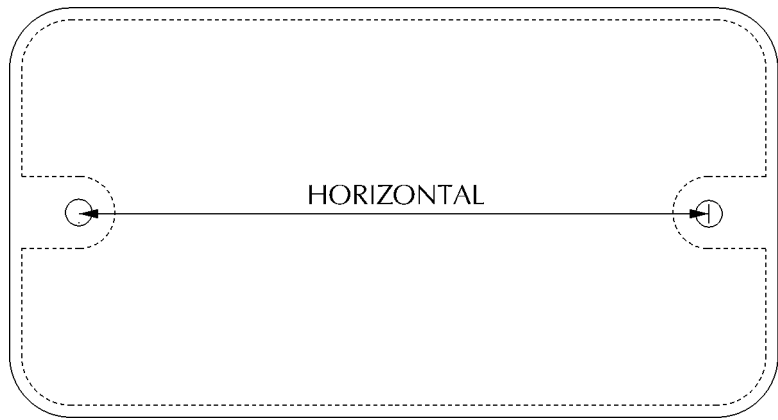

Junction Box templates: 2x4 "Handybox" Wall J-box  
Please print as 1:1 Scale on 8x11 Letter for best results

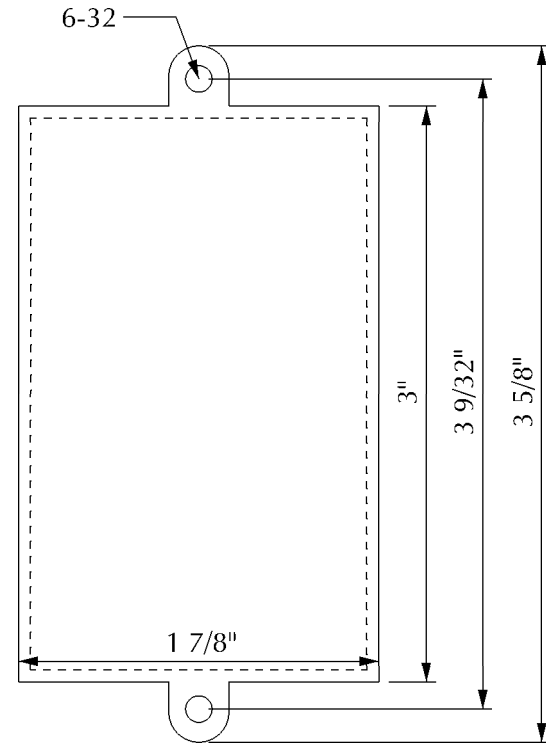
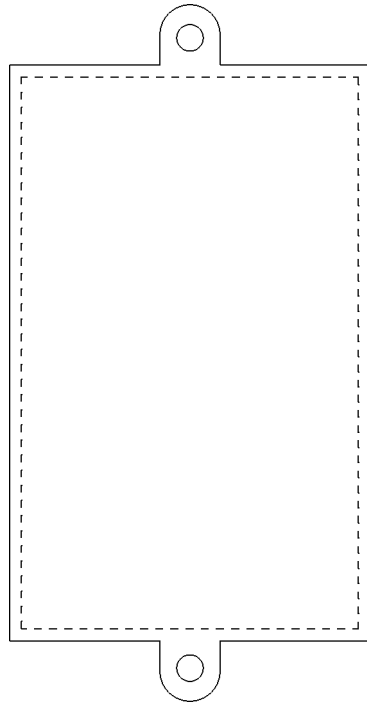

Junction Box templates: 2x4 "SWITCHBOX" Wall J-box  
Please print as 1:1 Scale on 8x11 Letter for best results

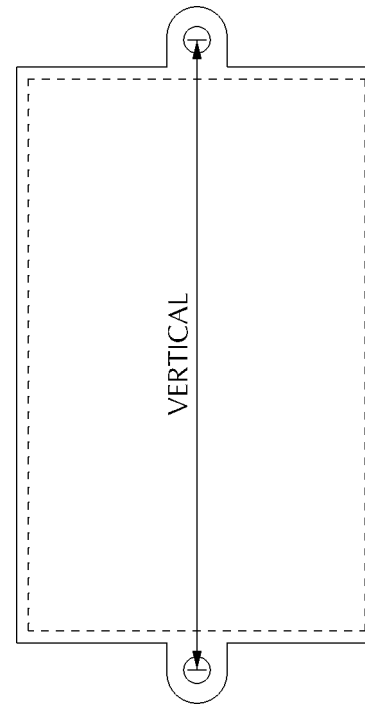
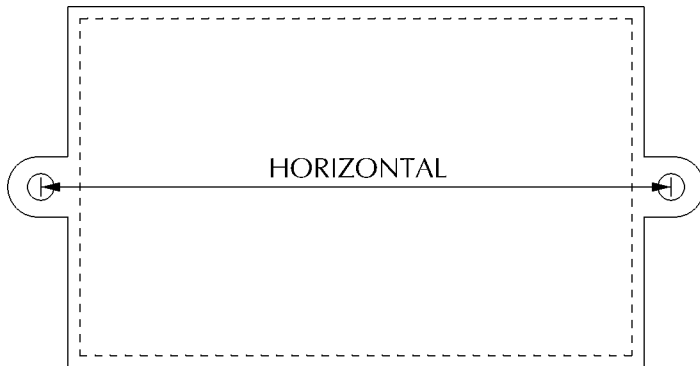

Junction Box templates: 2x4 "SWITCHBOX" Wall J-box Orientation  
Please print as 1:1 Scale on 8x11 Letter for best results

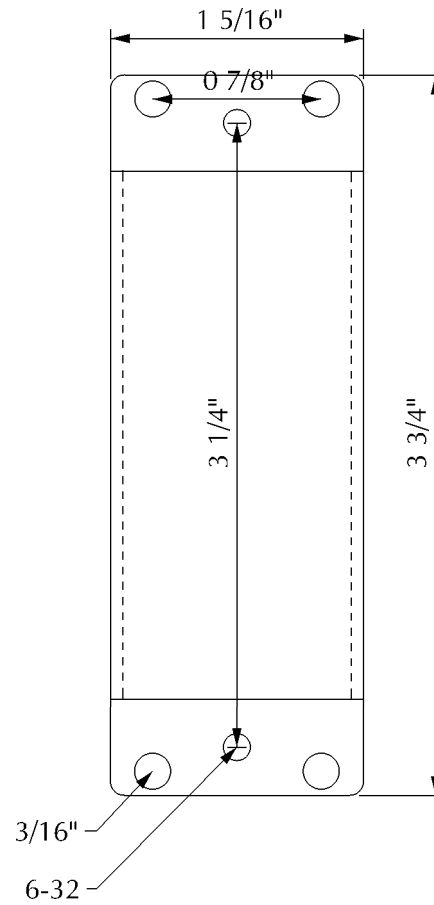
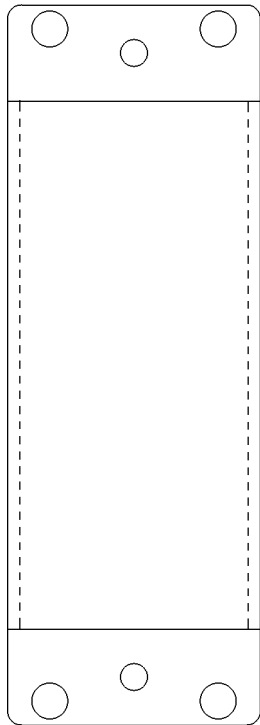

Junction Box templates: Miniature J-box  
Please print as 1:1 Scale on 8x11 Letter for best results

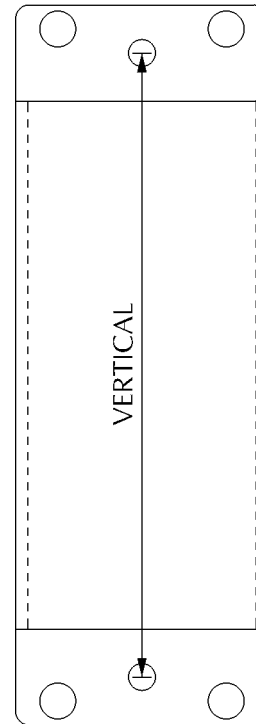

Junction Box templates: MINI J-box Orientation  
Please print as 1:1 Scale on 8x11 Letter for best results