



5-Arm Hourglass Chandelier



The original Hourglass fixture was designed by Kim D'Oliveira of Morris Nathanson Design for the Mills Tavern in Rhode Island and the Wequassett Inn in Massachusetts.

The Hourglass is a multi-armed, hand-made chandelier with cherry mold blown glass referencing the shape of a traditional hourglass. Each piece of glass is unique and available in a choice of colors.

The fixture can be made as a single pendant, three, four or five arm chandelier or wall sconce.

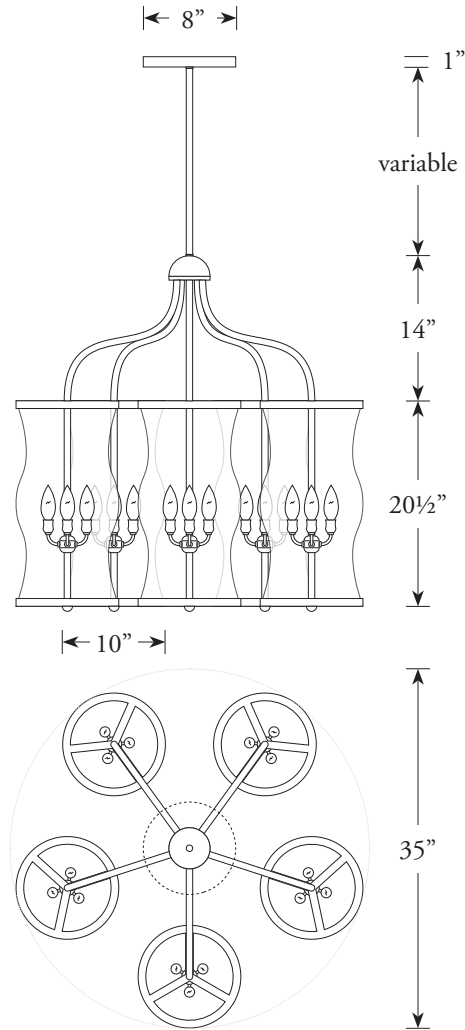

- Materials:** Wrought iron with brass hardware
- Finish:** Lacquered black patina
- Glass:** Hand blown glass hurricanes (available in clear or seedy)
- Lamp:** Three 60 watt B lamps or Xenon lamps
- Options:** Single pendant, three, four or five arm chandelier or wall sconce
- Designer:** Kim D'Oliveira of Morris Nathanson Design
- Notes:** Variable stem length / arm dimensions are variable

5-Arm Hourglass Chandelier

Overall Dimensions:

minimum height: 35½" x 35" diameter

Phone (718) 384-6039 • Fax (718) 384-6198
collection@auroralampworks.com

Retail Price: \$6,370.00
add \$65.00 for colored glass