



4-Arm Hourglass Chandelier

¾ size



The original Hourglass fixture was designed by Kim D'Oliveira of Morris Nathanson Design for the Mills Tavern in Rhode Island and the Wequassett Inn in Massachusetts.

The Hourglass is a multi-armed, hand-made chandelier with cherry mold blown glass referencing the shape of a traditional hourglass. Each piece of glass is unique and available in a choice of colors.

The fixture can be made as a single pendant, three, four or five arm chandelier or wall sconce.

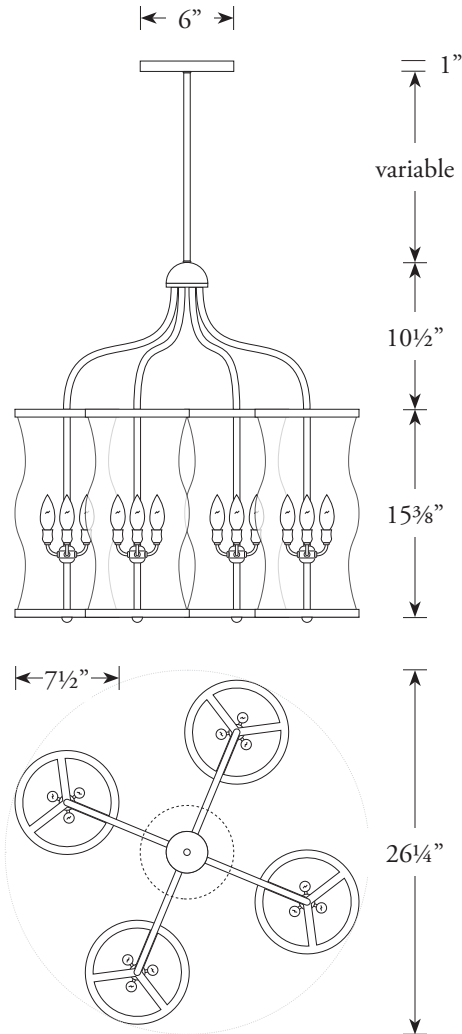

- Materials:** Wrought iron with brass hardware
- Finish:** Lacquered black patina
- Glass:** Hand blown glass hurricanes (available in clear or seedy)
- Lamp:** Three 60 watt B lamps or Xenon lamps
- Options:** Single pendant, three, four or five arm chandelier or wall sconce
- Designer:** Kim D'Oliveira of Morris Nathanson Design
- Notes:** Variable stem length / arm dimensions are variable

4-Arm Hourglass Chandelier

¾ size

Overall Dimensions:

minimum height: 26⁷/₈" x 26¹/₄" diameter

Phone (718) 384-6039 • Fax (718) 384-6198
collection@auroralampworks.com

Retail Price: \$5,525.00
add \$65.00 for colored glass